

ATLAS CORNER 198H

BOX ANGOLARE 2 ANTE SCORREVOLI
CORNER SHOWER ENCLOSURE WITH 2 SLIDING DOORS
ECKIGE DUSCHABTRENNUNG MIT ZWEI SCHIEBETÜREN
PAROI DE DOUCHE ANGULAIRE AVEC DEUX PORTES COULISSANTES
MAMPARA DE ESQUINA DOS PUERTAS CORREDERAS

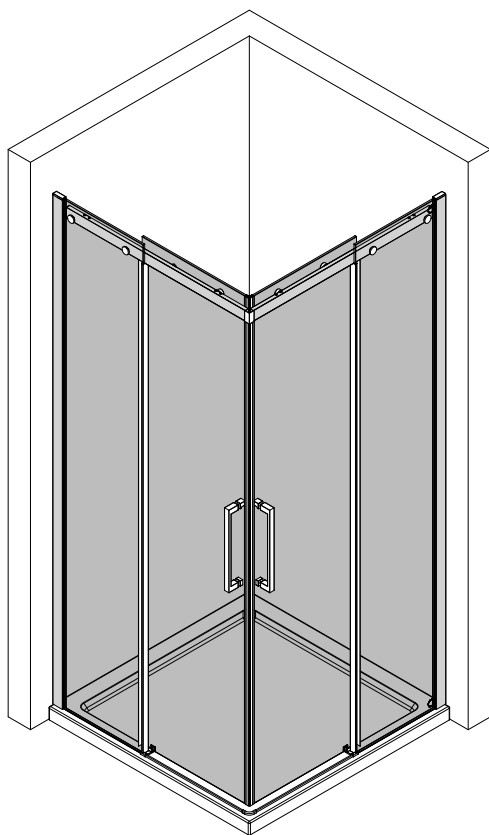

ISTRUZIONI DI MONTAGGIO & MANUALE DI CURA E MANUTENZIONE
ASSEMBLY INSTRUCTIONS & CARE AND MAINTENANCE MANUAL
MONTAGEANLEITUNG & PFLEGE UND WARTUNG HANDBUCH
INSTRUCTIONS DE MONTAGE & MANUEL SOIN ET MAINTENANCE
INSTRUCCIONES DE MONTAJE Y MANUAL DE CUIDADO Y MANTENIMIENTO

CONSIGLI PER LA CURA DAL PRODOTTO

I nostri prodotti sono realizzati secondo i più elevati standard qualitativi, utilizzando tecnologie d'avanguardia. La vita del prodotto è garantita per lungo tempo, se l'utilizzatore segue alcune semplici norme di cura ordinaria e di manutenzione periodica.

PULIZIA ORDINARIA

La pulizia ordinaria va eseguita utilizzando saponi neutri liquidi facilmente reperibili in commercio diluiti con acqua ed applicati con spugnette morbide.

ASCIUGATURA

L'asciugatura degli accessori a contatto con l'acqua (es: cerniere per box doccia) è vivamente consigliata, al fine di evitare l'accumulo di depositi calcarei e l'insorgere col tempo di fenomeni corrosivi. Per l'asciugatura usare un panno morbido o una pelle di daino.

MANUTENZIONE STRAORDINARIA PERIODICA

Eventuali depositi di calcare che si dovessero formare a causa del contatto dei nostri accessori con acque particolarmente dure e di una pulizia ordinaria non costante, possono essere rimossi agevolmente senza danneggiare il prodotto, tramite il lavaggio effettuato impiegando una soluzione al 15-20% di aceto diluito in acqua preferibilmente calda (un bicchiere per un litro d'acqua), seguito da un normale lavaggio con acqua e sapone neutro.

AVVERTENZE

Non usare mai, in nessun caso: comuni detersivi anticalcare, detersivi contenenti particelle abrasive, acido muriatico puro o diluito, candeggina/varekkina (sodio ipoclorito), acidi di uso domestico, soda caustica, pagliette metalliche, spugnette abrasive, scotch-brite.

L'impiego di questi prodotti può deteriorare irrimediabilmente la superficie degli accessori, annullando qualsiasi tipo di garanzia da parte del produttore.

CONSEJOS PARA LIMPIAR LOS PRODUCTOS COLCOM

Nuestros productos son fabricados con los más altos estándares de calidad, utilizando tecnologías de última generación.

La duración del producto está garantizada por un largo tiempo, si el usuario sigue algunas reglas simples de cuidado ordinario y mantenimiento regular.

LIMPIEZA DE RUTINA

La limpieza de rutina se realiza utilizando jabones neutros líquidos de fácil acceso en comercio diluidas con agua y aplicados con esponjas suaves.

SECADO

El secado de los accesorios en contacto con el agua (por ejemplo: bisagras para ducha) se recomienda fuertemente, a fin de prevenir la acumulación de depósitos calcáreos y la aparición de fenómenos de corrosión con el tiempo. Para el secado, utilizar un paño o una gamuza de cuero suave.

MANTENIMIENTO PERIÓDICO

Si depósitos calcáreos que se formaron debido al contacto de nuestros accesorios con agua particularmente dura y inconstante limpieza normal, se puede quitar fácilmente sin dañar el producto, por lavado utilizando una solución al 15-20% de vinagre diluido en agua, preferiblemente caliente (una copa de un litro de agua), seguido de un lavado normal con agua y jabón neutro.

AVISOS

Nunca utilice, bajo ninguna circunstancia: detergentes comunes de Descalcificador, detergentes que contienen partículas abrasivas, ácido muriático o diluido, blanqueador / lejía (hipoclorito de sodio), ácidos de uso doméstico, hidróxido de sodio, lana de acero, esponjas abrasivas, scotch-brite.

La utilización de estos productos puede dañar irreparablemente la superficie de los accesorios, anulando cualquier garantía del fabricante.

TIPS FOR THE CARE OF THE PRODUCT

Our products are manufactured according to the highest quality standards, using advanced technology. The life of the product is guaranteed for a long time, if the user follows a few simple rules of ordinary care and regular maintenance.

ROUTINE CLEANING

General cleaning should be performed using ordinary neutral liquid soaps, easily available, diluted with water and applied with soft sponges.

DRYING

Drying of the accessories in contact with water (e.g. hinges for shower boxes) is strongly recommended, in order to avoid the accumulation of limescale deposits and the onset of corrosion phenomena in time. For drying, use a soft cloth or chamois leather.

EXTRAORDINARY PERIODIC MAINTENANCE

Any limescale that should form due to contact of our accessories with particularly hard water, and a non-constant routine cleaning can be easily removed without damaging the product through washing carried out using a solution of 15-20% vinegar diluted with water, preferably hot (one glass per liter of water), followed by a normal washing with water and soap.

WARNINGS

Never use, in any case: ordinary detergents scale, detergents containing abrasive particles, pure or diluted muriatic acid, bleach (sodium hypochlorite), household acids, caustic soda, steel wool, scouring pads, scotch-brite.

The use of these products can irreparably damage the surface of the accessories, nullifying any warranty granted by the manufacturer.

TIPPS FÜR DIE PFLEGE DES PRODUKTS

Unsere Produkte werden nach den höchsten Qualitätsstandards hergestellt, unter Verwendung modernster Technologien. Die Lebensdauer des Produkts wird für eine lange Zeit garantiert, wenn der Benutzer ein paar einfachen Regeln für eine alltägliche Pflege und eine regelmäßige Wartung folgt.

ALLTÄGLICHE REINIGUNG

Die Reinigung sollte mit gewöhnlichen, neutralen, flüssigen, problemlos auf dem Markt erhältlichen Seifen durchgeführt werden. Die sollen mit Wasser verdünnt werden und durch einen weichen Schwamm aufgetragen werden.

TROCKNUNG

Die Trocknung des Zubehörs in Kontakt mit Wasser (z.B. Scharniere für Duschkabinen) wird dringend empfohlen, um die Ansammlung von Kalkablagerungen und das Auftreten von Korrosionserscheinungen zu vermeiden. Zum Trocknen benutzen Sie ein weiches Tuch oder Fensterleder.

PERIODISCHE AUßERORDENTLICHE WARTUNG

Jede Kalkablagerungen, die nach dem Kontakt unserer Zubehöre mit besonders hartem Wasser oder wegen einer unregelmäßigen Reinigung entstehen sollten, können leicht und ohne das Produkt zu beschädigen entfernt werden, durch das Waschen unter Verwendung einer Lösung von 15-20% Essig verdünnt mit Wasser, vorzugsweise heiß (ein Glas pro Liter Wasser); infolgedessen waschen Sie normal durch Wasser und Seife.

WARNUNGEN

Verwenden Sie niemals, in keinem Fall: normale Waschmittel-Skala, Reinigungsmittel mit abrasiven Partikeln, pur oder verdünnter Salzsäure, Bleichmittel (Natriumhypochlorit), Haushalts-Säuren, Natronlauge, Stahlwolle, Scheuerschwämme, Scotch-Brite.

Der Einsatz dieser Produkte kann irreparable Beschädigung der Oberfläche der Zubehöre verursachen, damit jegliche Gewährleistung des Herstellers zunichtend.

CONSEILS POUR LE SOIN DU PRODUIT

Nos produits sont fabriqués selon les plus élevées normes de qualité, utilisant technologies de pointe. La durée du produit est garantie pendant longtemps, si l'utilisateur suit quelques règles simples de soins ordinaire et maintenance régulière.

NETTOYAGE DE ROUTINE

Le nettoyage de routine est effectuée en utilisant des savons liquides neutres facilement disponibles dans le commerce, dilué avec de l'eau et appliquées avec des éponges douces.

SÉCHAGE

Le séchage des accessoires en contact avec de l'eau (par exemple: charnières pour paroi) est fortement recommandée, afin d'éviter l'accumulation de dépôts calcaires et l'apparition des phénomènes de corrosion au cours du temps. Pour le séchage, utiliser un chiffon doux ou un chamouis.

ENTRETIENS PÉRIODIQUES

Si dépôts calcaires qui ont été formés par le contact de nos accessoires avec de l'eau très dur et un pas constant nettoyage de routine, peut être éliminé facilement sans endommager le produit, par un lavage effectué en utilisant une solution à 15-20% de vinaigre dilué dans l'eau, de préférence chaud (un verre pour un litre d'eau), suivi d'un lavage normal avec de l'eau et un savon doux.

AVERTISSEMENTS

Jamais utiliser, en aucune circonstance : détergents ordinaires anticalcaire, détergents contenant des particules abrasives, acide muriatique ou dilué, eau de Javel / agent de blanchiment (hypochlorite de sodium), acides à usage domestique,hydroxyde de sodium,laine d'acier,éponges abrasives, Scotch-Brite.

L'utilisation de ces produits peut irrémédiablement endommager la surface des accessoires, annulant toute garantie du fabricant.

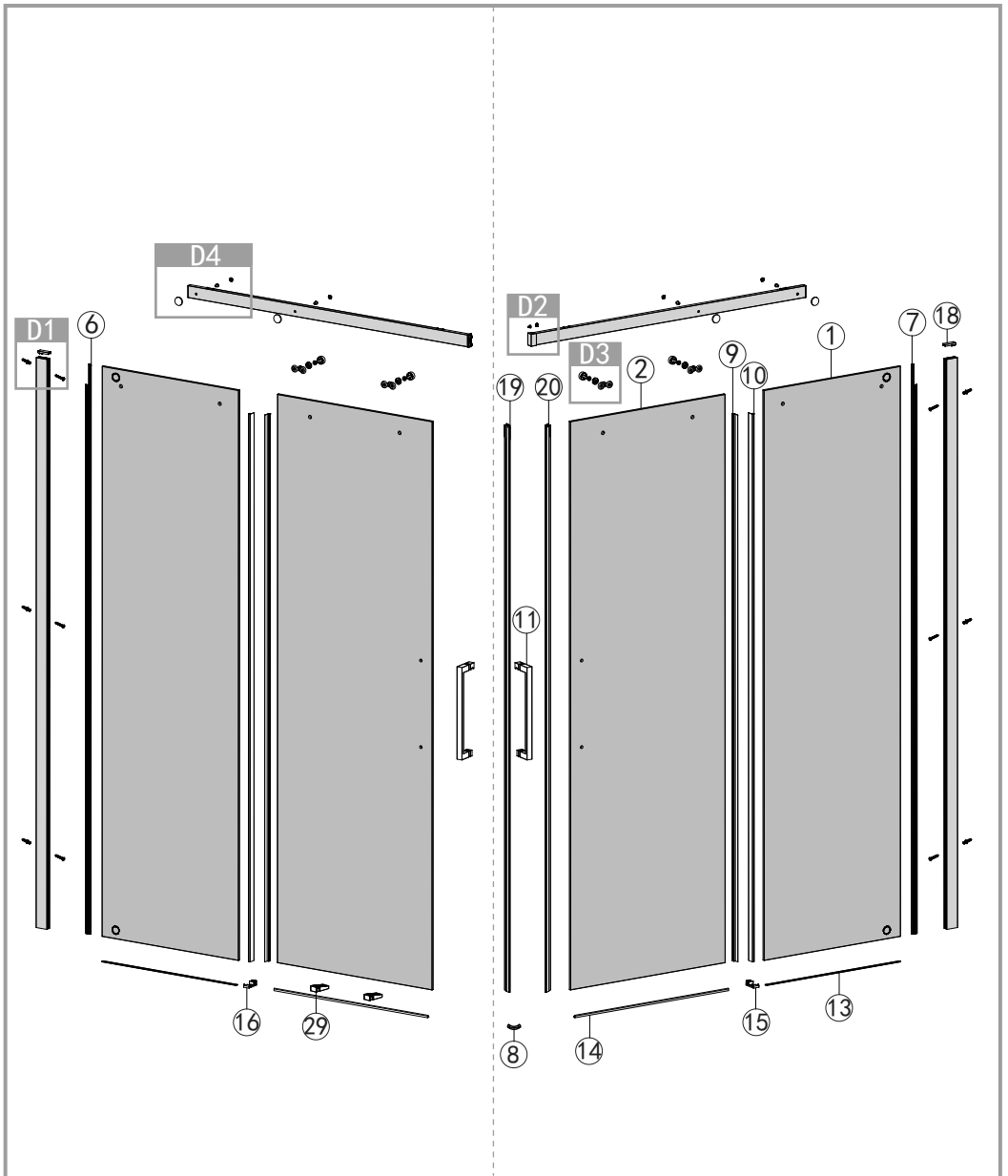

D1

D2





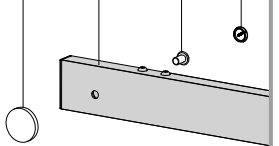
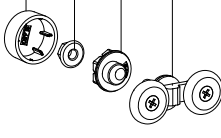
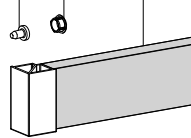
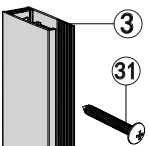

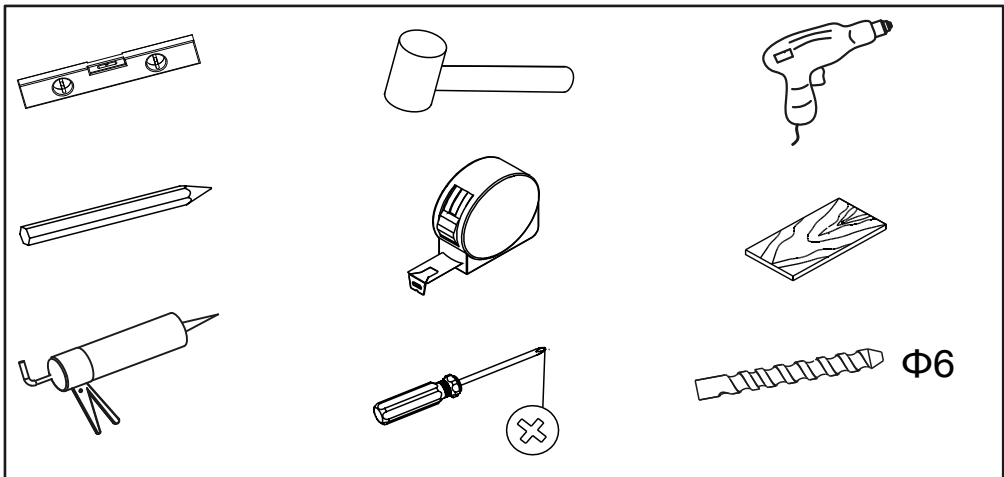
D3

D4



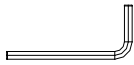

1			x2	14		LC272	x2
2			x2	15		SLB637	x1
3			x2	16		SLB640	x1
4			x1	17		SLB646	x1
5			x1	18		SLB647	x1
6		DS1301973B	x1	19		CT034	x1
7		DS1301973A	x1	20		CT035	x1
8		SLB484	x1	21		LD077	x1
9		DS1591894	x2	22		SLB650	x4
10		DS1591897	x2	23		LD144	x4
11		LS036	x2	24		SLA649	X4
12		SLB215	x1	25		LZ043	x4
13			x2	26		SLB652	x4

27		LD142	x4	31		LD001A	x8
28		WJ0330	x4	32		WJ0224	x1
29		SLG468	x2	33		WJ0343	x1
30		SLD059	x8				

1

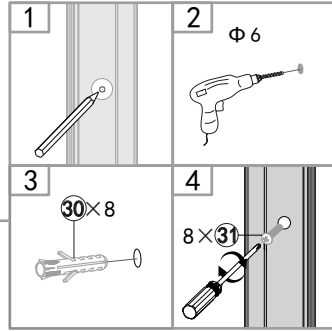
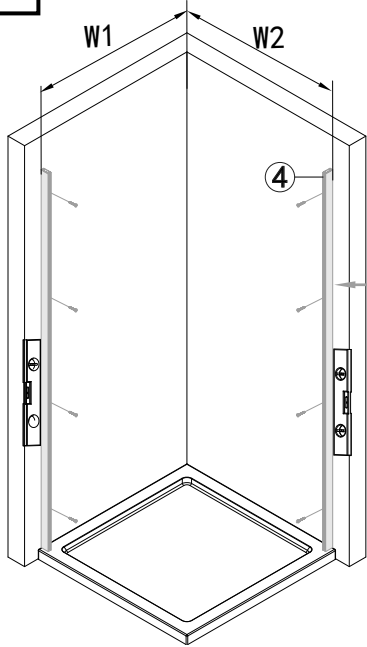

	W1	W2
700	680-700	680-700
750	730-750	730-750
800	780-800	780-800
900	880-900	880-900
1000	980-1000	980-1000
1100	1080-1100	1080-1100
1200	1180-1200	1180-1200

2

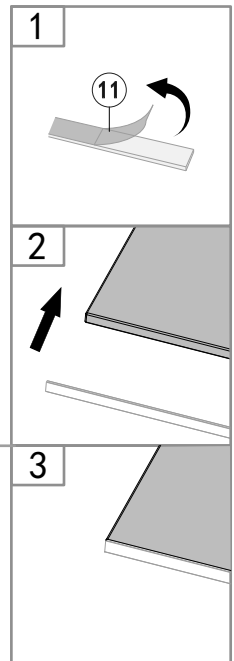
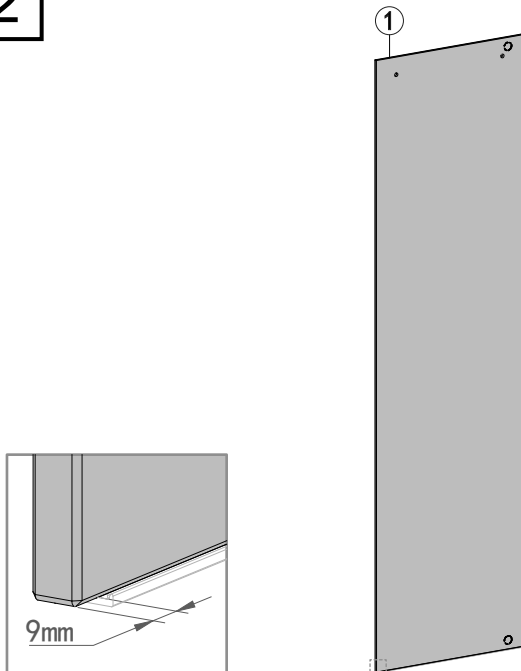

3

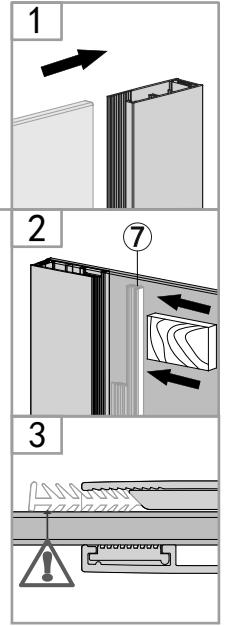
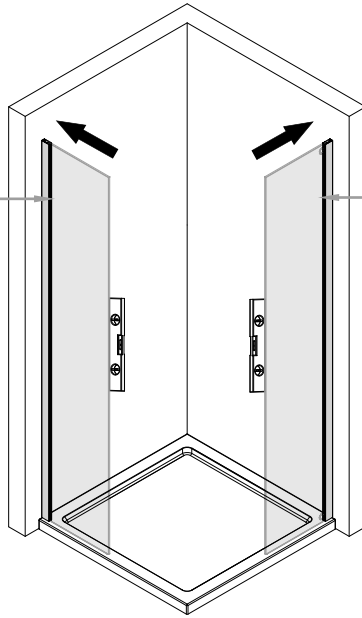
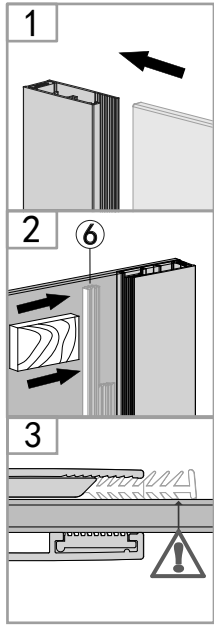

4

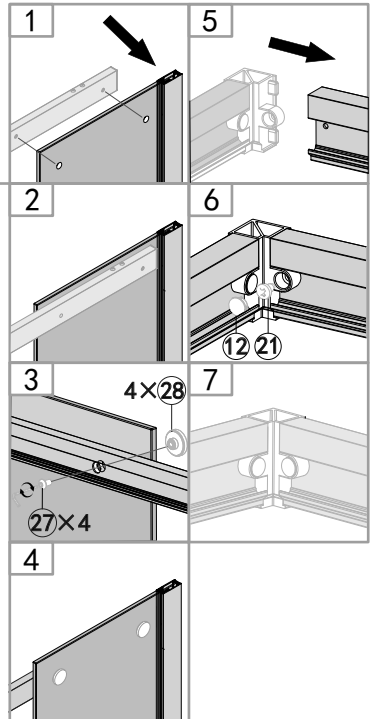
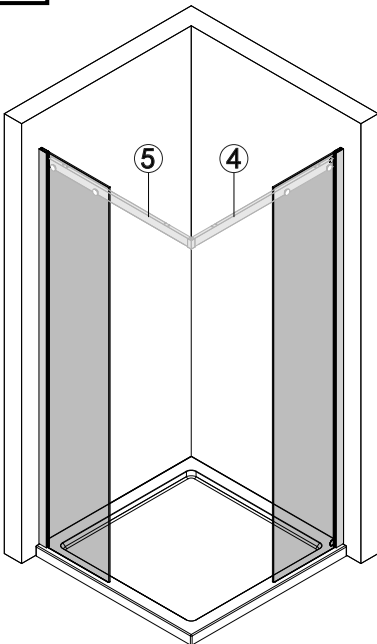

5

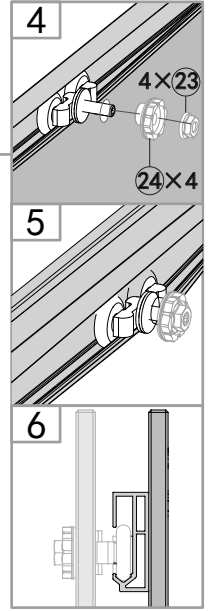
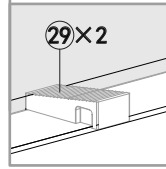
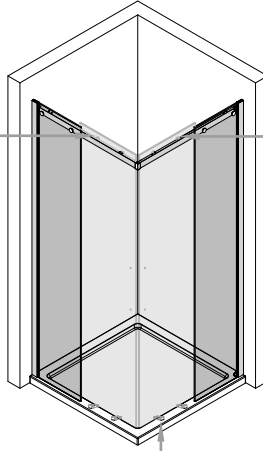
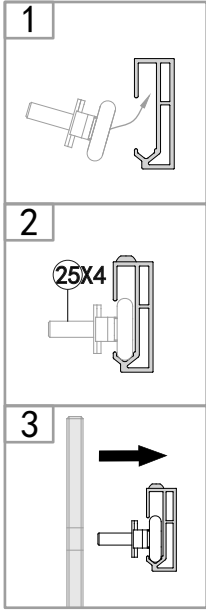

6

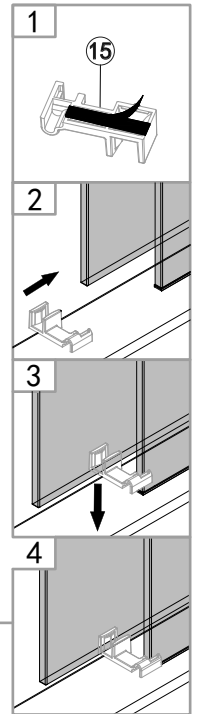
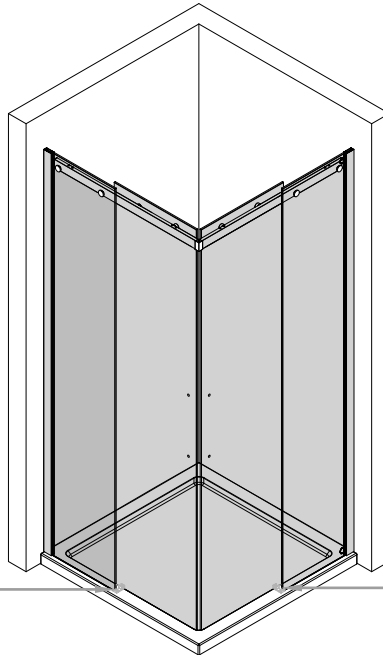
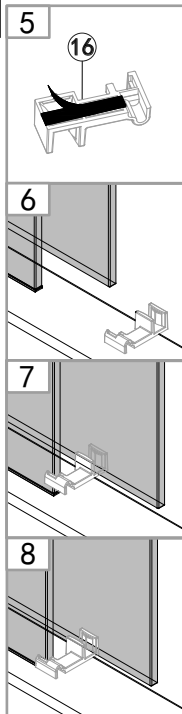

7

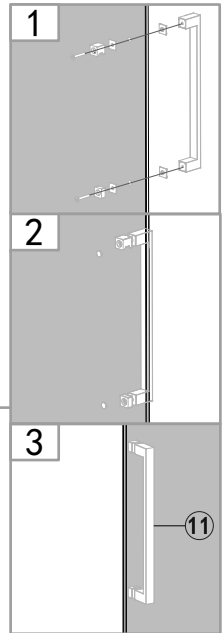
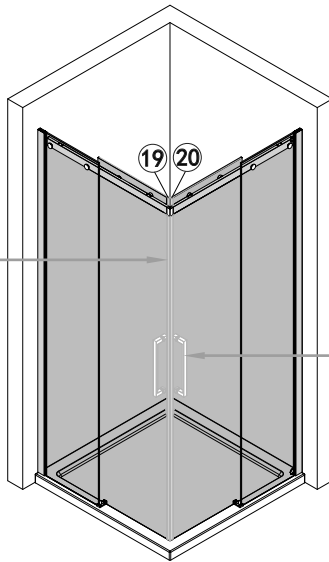
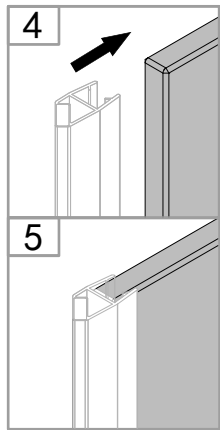

8

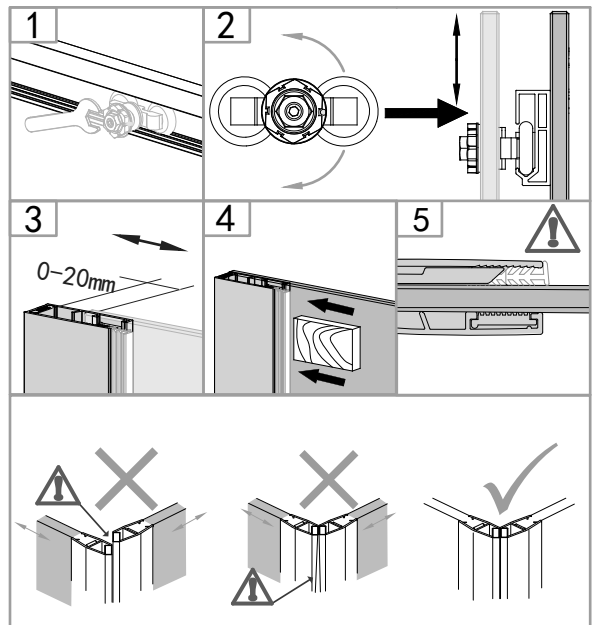
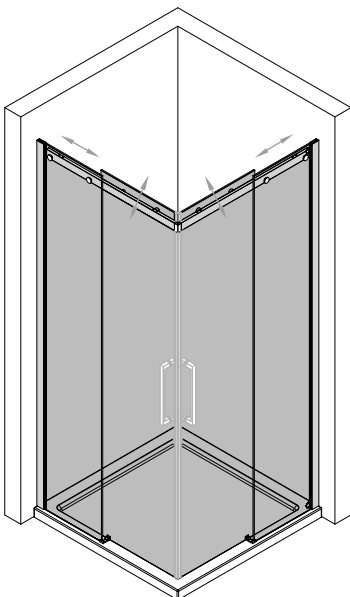

9

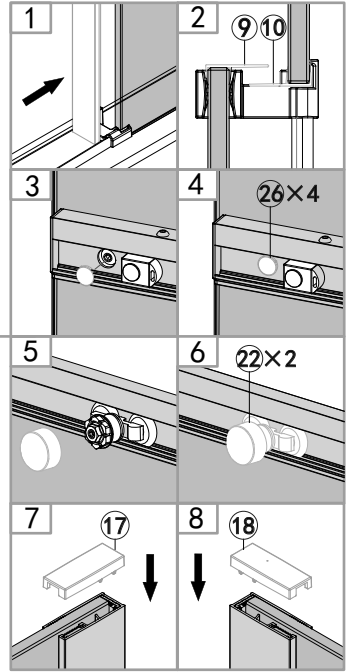
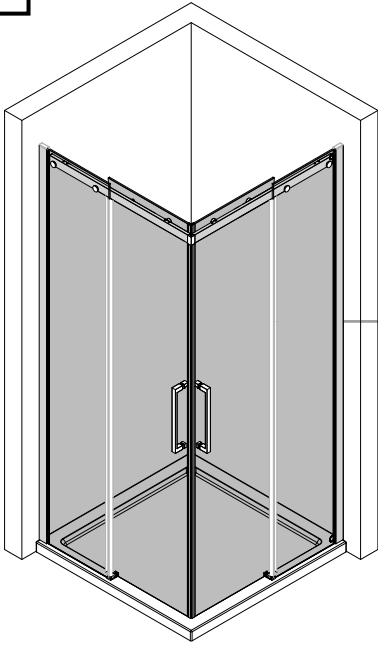

10

